



A Practical Guide to AutoCAD® 2021

Tracy Chadwick and Rick Ellis

Foreword written by Lynn Allen



A CADapult Press Publication

Copyright

Copyright © CADapult Press, Inc. 2020

All rights reserved. No part of this publication may be reproduced in any form, or by any means electronic, mechanical, recording, photocopying, or otherwise, without written permission from the publisher, except for brief quotations used in reviews, or for marketing purposes specific to the promotion of this work.

ISBN: 978-1-934865-52-1

Although CADapult Press has made every attempt to ensure the accuracy of the contents of this book, the publisher and author make no representations or warranty with respect to accuracy or completeness of the contents in this book, including without limitation warranties of fitness for a particular purpose. The datasets included in this book are for training purposes only.

Autodesk screen shots reprinted with the permission of Autodesk, Inc.

Autodesk, AutoCAD, DWG, and the DWG logo are registered trademarks or trademarks of Autodesk, Inc., and/or its subsidiaries and/or affiliates in the USA and other countries. All other trademarks are the property of their respective owners.

Published in the United States of America by:

CADapult Press

(503) 829-8929

books@cadapult-software.com

Printed and manufactured in the United States of America

About the Authors

Tracy Chadwick serves as coordinator and instructor for the Computer Drafting Technology program at Hutchinson Community College in Hutchinson, Kansas. He is responsible for teaching a wide range of courses, including those on engineering graphics, AutoCAD software, Inventor software, and Revit Architecture software.

Tracy has been an AutoCAD user since 1995, and has been teaching AutoCAD classes to working professionals and college students since 2001. His experience and dedication to teaching led to him being recognized by Autodesk, Inc. with the North America Award for Distinguished Performance in AutoCAD Software Training.

Tracy has also been recognized as a top rated speaker at Autodesk University, where he has presented for several years. He has recently begun serving as a mentor to first-time Autodesk University speakers.

Tracy can be reached at: tracy@cadapult-software.com

Rick Ellis has worked with and taught AutoCAD Map 3D since the mid-90s, along with Civil 3D and other Autodesk products. He is the Author of several critically acclaimed books on AutoCAD Map 3D, Civil 3D and Land Desktop.

Rick continues to use AutoCAD Map 3D on projects in a production environment, in addition to teaching classes to organizations both large and small.

This practical background and approach has made him an award winning speaker at Autodesk University and a sought after instructor by organizations around the world.

Rick can be reached at: rick@cadapult-software.com

Acknowledgements

Thank you to my wonderful wife Candace, and my two amazing daughters Sydney and Casey. Without their support I could never have completed this book. Thank you to all the students of the Computer Drafting Technology program at Hutchinson Community College. I am honored to have played a part in helping so many students achieve fulfilling careers over the last two decades. Thank you to Vince Puyear, who first introduced me to AutoCAD back in 1995. He started as my instructor, then later became my colleague, mentor, and friend. Thank you to Amber Brawner for lending her graphic design talent to this book, and for being a great friend. Last, but not least, thank you to Rick Ellis and CADapult Press for helping me to achieve my dream of being an author, so that I may spread my love for AutoCAD from beyond central Kansas to the world!

-Tracy Chadwick

A Practical Guide to AutoCAD® 2021

Introduction

Congratulations on choosing this course to help you learn how to use AutoCAD 2021. The term “practical” is used in the title because this course focuses on what you need to effectively use AutoCAD 2021, and does not complicate your learning experience with unnecessary details of every feature in the product. Should you want to pursue aspects of features and functionality in greater detail than provided in this course, you are directed and guided to that information.

Each lesson contains the concepts and principles of each feature to provide you with the background and foundation of knowledge that you need to complete the lesson. You then work through exercises to reinforce your understanding and provide you with practice on common tasks that other professionals are performing with AutoCAD 2021 in the workplace every day.

Most lessons include a *Challenge Exercise* at the end. These exercises ask you to perform tasks based on what you learned in the lesson without the step-by-step instructions to test your skills and understanding of the new material.

When you complete this course, you will be armed with the background and knowledge to apply AutoCAD to your job tasks, and become more effective and productive in your job.

Course Objectives

The objectives of this course are performance based. In other words, once you have completed the course, you will be able to perform each objective listed. If you are already familiar with AutoCAD, you will be able to analyze your existing workflows, and make changes to improve your performance based on the tools and features that you learn and practice in this course.

After completing this course, you will be able to:

- Understand the user interface
- Navigate through drawings with pan and zoom commands
- Create drawing objects, including lines, arcs, and circles
- Create and modify polylines, including rectangles and polygons
- Use Layers to differentiate drawing objects
- Draw using Polar Tracking and coordinate methods
- Use Object Snaps and Object Snap Tracking
- Modify drawing objects
- Duplicate drawing objects
- Extract information from drawings with measuring tools
- Create and modify hatch patterns
- Create, insert, and modify blocks
- Work with external references
- Import a PDF
- Create and scale paper space layouts and viewports
- Print scale drawings and check plots
- Detail drawings with text, dimensions, and leaders

Downloading and Installing the Datasets

In order to perform the exercises in this book, you must download a zip file and install the datasets.

Type the address below into your web browser to load the page where you can download the dataset.

www.cadapult-software.com/data

Unzip the Files

Unzip the file **APG_AutoCAD2021.zip** directly to the C drive. The zip file will create the following folder structure:

C:\A Practical Guide\AutoCAD 2021\Files for Exercises

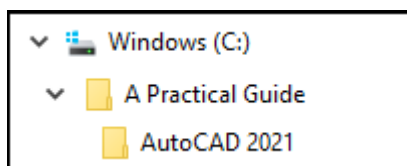

Exercises

The exercises in this course have been carefully chosen and designed to represent common tasks that are performed by design professionals.

The exercise files are from many different industries and are meant only to be examples. It's important to focus on the tools being shown and how you could apply them to your project and industry.

Exercises provide higher level process information throughout the exercise tasks. You are given information about not only what to do, but why you are doing it. In most cases, an image is included to help guide you.

Most lessons include a *Challenge Exercise* at the end. These exercises ask you to perform tasks based on what you learned in the lesson without the step-by-step instructions to test your skills and understanding of the new material. If you get stuck in these exercises go back and review the information in the lesson for guidance.

Table of Contents

Chapter 1 Introduction to AutoCAD	1
1.1. Lesson: Navigating the AutoCAD User Interface	2
1.1.1 Navigating the AutoCAD Interface	8
1.2. Lesson: Working with AutoCAD Drawing Files	10
1.2.1 Working with AutoCAD Drawings	17
1.3. Lesson: Basic AutoCAD Tools	20
1.4. Lesson: Selection Techniques.....	26
1.4.1 Selection Techniques.....	29
Chapter 2 Drawing Lines and Working with Layers	31
2.1. Lesson: Drawing Lines	32
2.1.1 Drawing Lines	35
2.2. Lesson: Drawing with Cartesian Coordinates	37
2.2.1 Drawing a Rectangle with Absolute Coordinates.....	41
2.2.2 Drawing a More Complex Shape with Absolute Coordinates.....	42
2.2.3 Drawing a Rectangle with Relative Coordinates.....	43
2.2.4 Drawing a More Complex Shape with Relative Coordinates	44
2.2.5 Drawing a Rectangle with Polar Coordinates	46
2.2.6 Drawing a More Complex Shape with Polar Coordinates.....	47
2.3. Drawing with Polar Tracking.....	49
2.3.1 Drawing a Rectangle with Polar Tracking	56
2.3.2 Drawing a More Complex Shape with Polar Tracking	58
2.3.3 Drawing with Additional Polar Tracking Angles	60
2.3.4 Drawing with Architectural Units	62
2.3.5 Challenge Exercise - Polar Tracking.....	64
2.4. Drawing with Layers	65
2.4.1 Drawing with Layers.....	72
2.4.2 Changing the Layers of Existing Objects	74
2.4.3 Modifying Layer States	75
2.4.4 Creating and Modifying Layers	77
2.4.5 Challenge Exercise - Layers	80
Chapter 3 Drawing Additional Objects (Part I)	81
3.1. Drawing Circles.....	82
3.1.1 Drawing Circles with the Center, Radius and Center, Diameter Methods.....	85
3.1.2 Additional Practice with the Center, Radius and Center, Diameter Methods	86

3.1.3	Drawing Circles with the 2-Point and 3-Point Methods	87
3.1.4	Drawing Circles with Tangent Methods	88
3.1.5	Challenge Exercise - Drawing Circles	90
3.2.	Drawing Rectangles	91
3.2.1	Drawing Rectangles	93
3.2.2	Challenge Exercise - Drawing Rectangles	95
3.3.	Drawing Polygons	96
3.3.1	Drawing Polygons	99
3.3.2	Additional Practice Drawing Polygons	100
3.3.3	Challenge Exercise - Drawing Polygons	101
Chapter 4	Object Snaps and Object Snap Tracking	103
4.1.	Drawing with Object Snaps	104
4.1.1	Drawing with Endpoint, Midpoint, and Quadrant Object Snaps	111
4.1.2	Drawing with Center and Tangent Object Snaps	114
4.1.3	Drawing with Node and Perpendicular Object Snaps	116
4.1.4	Drawing with Intersection and Geometric Center Object Snaps	118
4.1.5	Drawing with Object Snap Overrides	120
4.1.6	Additional Practice Drawing with Object Snap Overrides	122
4.1.7	Challenge Exercise - Objects Snaps #1	124
4.1.8	Challenge Exercise - Objects Snaps #2	125
4.2.	Drawing with Object Snap Tracking	126
4.2.1	Tracking Off of a Single Point with Object Snap Tracking	131
4.2.2	Object Snap Tracking of Multiple Points	133
4.2.3	Challenge Exercise - Objects Snap Tracking	135
Chapter 5	Drawing Additional Objects (Part II)	137
5.1.	Drawing Arcs	138
5.1.1	Drawing Arcs	144
5.1.2	Additional Practice Drawing Arcs	146
5.1.3	Challenge Exercise - Drawing Arcs	149
5.2.	Drawing and Editing Polylines	150
5.2.1	Drawing Polylines	157
5.2.2	Drawing Polylines with Varying Widths	159
5.2.3	Editing Polylines	162
5.2.4	Challenge Exercise - Drawing Polylines	164

Chapter 6 Modifying Drawing Objects	167
6.1. Moving Drawing Objects.....	168
6.1.1 Moving Drawing Objects	170
6.1.2 Additional Practice Moving Objects	171
6.1.3 Challenge Exercise - Moving Drawing Objects.....	176
6.2. Scaling Drawing Objects	177
6.2.1 Scaling Objects	180
6.2.2 Scaling Drawing Objects with the Reference Option	183
6.2.3 Challenge Exercise - Scaling Drawing Objects	185
6.3. Stretching Drawing Objects	186
6.3.1 Stretching Drawing Objects	188
6.3.2 Challenge Exercise - Stretching Drawing Objects	191
6.4. Rotating Drawing Objects.....	192
6.4.1 Rotating Drawing Objects	196
6.4.2 Rotating Objects with Polar Tracking.....	199
6.4.3 Rotating Objects with the Reference Option.....	201
6.4.4 Challenge Exercise - Rotating Drawing Objects.....	203
6.5. Trimming Drawing Objects	204
6.5.1 Trimming Drawing Objects.....	211
6.6. Extending Drawing Objects	214
6.6.1 Extending Drawing Objects.....	220
6.6.2 Additional Practice Trimming and Extending Objects.....	222
6.6.3 Challenge Exercise - Trimming and Extending Drawing Objects	226
6.7. Creating Rounded Corners with the Fillet Command.....	227
6.7.1 Filleting Drawing Objects	232
6.7.2 Additional Practice Filleting Drawing Objects	236
6.7.3 Challenge Exercise - Filleting Drawing Objects.....	238
6.8. Creating Angled Corners with the Chamfer Command.....	239
6.8.1 Chamfering Drawing Objects	247
6.8.2 Challenge Exercise - Chamfering Drawing Objects.....	253
Chapter 7 Duplicating Drawing Objects.....	255
7.1. Copying Drawing Objects	256
7.1.1 Copying Drawing Objects	258
7.1.2 Exercise: Additional Practice Copying Objects.....	260
7.1.3 Challenge Exercise - Copying Drawing Objects	262
7.2. Mirroring Drawing Objects	263
7.2.1 Mirroring Drawing Objects	266

7.2.2	Additional Practice Mirroring Objects	268
7.2.3	Challenge Exercise - Mirroring Drawing Objects	271
7.3.	Creating Rectangular Arrays of Drawing Objects	272
7.3.1	Creating a Rectangular Array	276
7.3.2	Additional Practice Creating Rectangular Arrays	280
7.3.3	Challenge Exercise - Rectangular Array	283
7.4.	Creating Polar Arrays of Drawing Objects	284
7.4.1	Creating a Polar Array	290
7.4.2	Additional Practice Creating Polar Arrays	294
7.4.3	Creating Polar Arrays with Multiple Rows	296
7.4.4	Challenge Exercise - Polar Array	298
7.5.	Creating Path Arrays of Drawing Objects	299
7.5.1	Creating Path Arrays Using the Measure Method.....	304
7.5.2	Creating Path Arrays Using the Divide Method.....	307
7.5.3	Challenge Exercise - Path Array	309
7.6.	Offsetting Drawing Objects	310
7.6.1	Offsetting Drawing Objects.....	314
7.6.2	Additional Practice Offsetting Objects	317
7.6.3	Challenge Exercise - Offsetting Drawing Objects	320
7.7.	Modifying Drawing Objects with Grips	321
7.7.1	Grip Editing Drawing Objects	326
Chapter 8	Inquiry Tools.....	331
8.1.	Measure commands.....	332
8.1.1	Measuring Distance, Area, and Perimeter	348
8.1.2	Measuring Distance, Radius, Area, and Angle	351
8.1.3	Measuring Angles.....	355
8.1.4	Measuring with the Quick Measure Tool.....	357
8.1.5	Challenge Exercise - Measure Commands.....	358
8.2.	Object Properties	361
8.2.1	Viewing and Modifying Object Properties.....	368
Chapter 9	Adding and Modifying Hatch Patterns.....	373
9.1.	Adding and Modifying Hatch Patterns.....	374
9.1.1	Adding Hatch Patterns.....	381
9.1.2	Additional Practice Adding Hatch Patterns.....	385
9.1.3	Challenge Exercise - Adding Hatch Patterns	390

Chapter 10	Working with Blocks, External References, and PDF Files.....	391
10.1.	Inserting Blocks	392
10.1.1	Inserting Blocks with the Blocks Palette	402
10.1.2	Inserting Dynamic Blocks.....	409
10.1.3	Inserting Blocks with Tool Palettes	412
10.1.4	Inserting Blocks with DesignCenter	415
10.1.5	Challenge Exercise - Inserting Blocks	419
10.2.	Creating Blocks.....	420
10.2.1	Creating Local Blocks	426
10.2.2	Creating Global Blocks	432
10.2.3	Challenge Exercise - Creating Blocks.....	437
10.3.	Attaching External References	438
10.3.1	Working with External References.....	443
10.3.2	Challenge Exercise - External References	447
10.4.	Importing PDF Files	448
10.4.1	Importing PDF Files	452
10.4.2	Challenge Exercise - Importing PDF Files	457
Chapter 11	Plotting Drawings	459
11.1.	Plotting Drawings from Model Space	460
11.1.1	Plotting from Model Space.....	463
11.1.2	Challenge Exercise - Plotting from Model Space	468
11.2.	Plotting Drawings from Paper Space.....	469
11.2.1	Plotting from Paper Space	475
11.2.2	Challenge Exercise - Plotting from Paper Space.....	482
Chapter 12	Annotating Drawings.....	483
12.1.	Adding and Modifying Text	484
12.1.1	Adding Text Notes to a Drawing	488
12.1.2	Additional Practice Adding Text Notes to a Drawing	491
12.1.3	Challenge Exercise - Adding Text.....	494
12.2.	Adding and Modifying Dimensions	495
12.2.1	Adding Linear Dimensions	505
12.2.2	Adding Aligned and Angular Dimensions	507
12.2.3	Adding Radius and Diameter Dimensions	509
12.2.4	Adding Continuous and Baseline Dimensions.....	513
12.2.5	Challenge Exercise - Adding Dimensions #1.....	515
12.2.6	Challenge Exercise - Adding Dimensions #2.....	516

12.3. Adding and Modifying Leaders.....	517
12.3.1 Adding Leaders	524
12.3.2 Adding Balloons with the Multileader Command.....	527
12.3.3 Challenge Exercise - Adding Leaders	532
Index	535

Foreword

Welcome to the wonderful world of AutoCAD. I say that somewhat tongue and cheek as learning AutoCAD can be somewhat daunting – and no doubt why you’ve chosen to pick up this book. I commend you for not trying to learn AutoCAD completely on your own (a dreadful route to take) but for relying on the skillful guidance of Tracy Chadwick and Rick Ellis. These two award winning authors have been teaching AutoCAD for many years and know exactly what it takes to lead the beginning user through the oft overwhelming tools inside of AutoCAD. This ***A Practical Guide of AutoCAD 2021*** will focus on the all-important basics of the product and steer you clear of the nonessential tools (you can tackle those later when you are more seasoned!) There is a right and a wrong way to use AutoCAD...this book will ensure that you learn how to use it the “right” way!

I taught AutoCAD at the collegiate and professional level for 11 years before joining Autodesk in their training department. I know the importance of good training materials and I know a great AutoCAD book when I see it. You are looking at one right now. Tracy and Rick have mastered the art of writing in terms that we can all understand without a need to impress or complicate the task at hand. Their goal is simple: to help you successfully use AutoCAD for your design work. They have taken their many years of training expertise and rolled it all into this well massaged book. How I wish I’d had this book when I was training people how to use AutoCAD!

In my 20+ year role as Autodesk Evangelist, I had the distinct privilege of working with Tracy and Rick at Autodesk University and other conferences. Their presentations are always highly rated and very popular with attendees. They have that special knack of connecting with an audience and making the difficult sound easy – which is exactly what you need when you are learning to use AutoCAD. You will experience this as you make your way through the chapters of this book.

A Practical Guide of AutoCAD 2021 also includes real-world examples from many different industries. You won’t be drawing any Mickey Mouses or smiley faces, but actual drafting examples. Let’s face it – you wouldn’t get a job with that limited skillset (well...unless you go work for Disney). The variety of practical examples used with practical commands is the perfect combination to get you prepared for drafting and designing in the real world.

Use this book to build a firm foundation for designing with AutoCAD. Those users with a firm foundation of the product do best overall in successfully mastering the product (another reason to read this book). Physically do as many exercises in the book as possible and you’ll be on the road to becoming a great AutoCAD user!

I’m pretty sure that your first thought when you’re finished with this book is going to be...”When are Tracy and Rick going to come out with an ***Advanced Practical Guide of AutoCAD?***” I know that’s my question!

Lynn Allen

Global Technology Evangelist

In her 20+ year career as Autodesk Technology Evangelist, Lynn Allen has spoken to more than a half million design professionals in over 50 countries throughout the world. Her online reach over the years easily reaches into the millions. An early CAD entrepreneur, Lynn taught AutoCAD at the corporate and collegiate level for 11 years before joining Autodesk. A popular columnist for Cadalyst magazine for over two decades, she is the face behind hundreds of software videos including the series “AutoCAD Tips and Tricks with Lynn Allen”. A sought-after public speaker with a unique comedic style, Lynn was the host of Autodesk University for over a decade and is always one of the highest rated presenters at the many worldwide Autodesk Universities. She is also the author of three technical books focused on AutoCAD software.

Sample Lesson

6.4. Rotating Drawing Objects

Introduction

In this lesson, you learn how to rotate drawing objects.

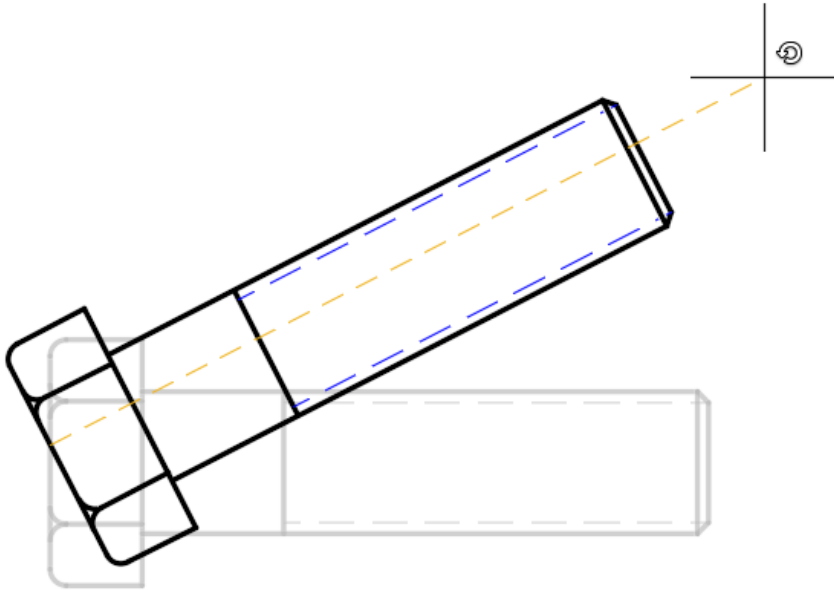

Key Concepts

Concepts and key terms covered in this lesson are:

- Rotating Objects
- Base Point
- Rotation Angle
- Reference Angle

Objectives

After completing this lesson, you will be able to:

- Rotate drawing objects.

About the Rotate Command

Many times while drawing you will have the need to adjust the orientation of drawing objects by rotating them. The Rotate command can achieve this in a few simple steps.

Starting the Rotate Command

The **Rotate** command is located at **Ribbon: Home** ⇒ **Modify** ⇒ **Rotate**.

Alternatively, you can type **RO** then press **[Enter]** at the keyboard.

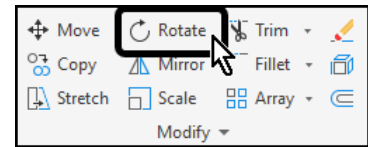

After starting the Rotate command, you are prompted to select the objects to be rotated.

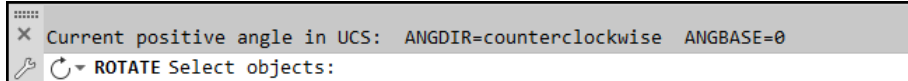

The Rotate command will allow you to select as many objects as you want. When you are finished selecting objects you must press **[Enter]** at the keyboard to move on to the next step.



Next you will specify the base point. This point will remain in the same location while the rest of the selected objects rotate around it.



Finally, the Command line asks for the rotation angle. The angle can be specified by typing a value or by selecting a point on-screen.

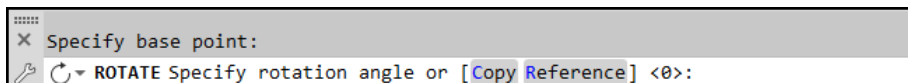

When entering a rotation angle value, it is important to remember that by default in AutoCAD, angles are positive when rotating in the counterclockwise direction; angles are negative when rotating in the clockwise direction.

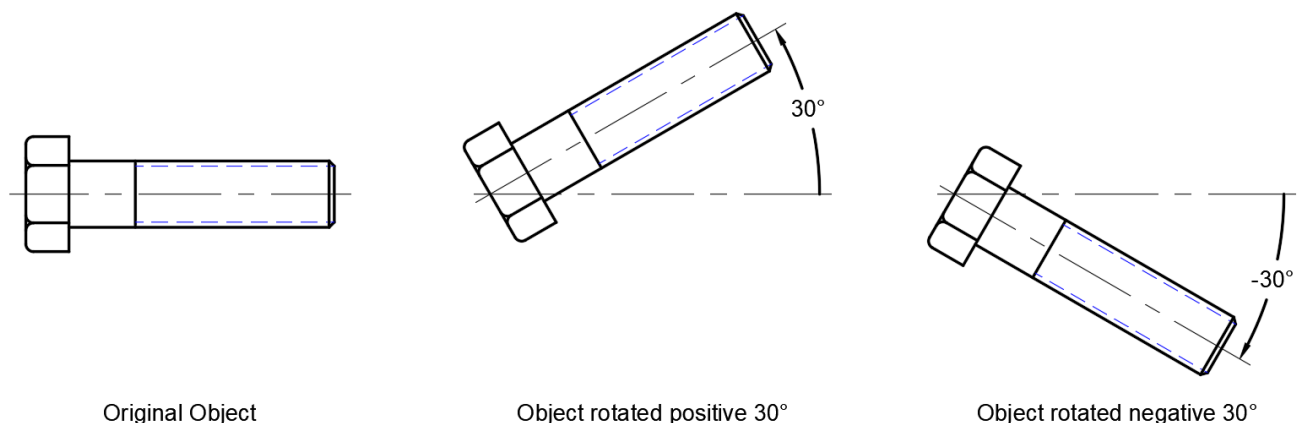

Instead of typing the rotation angle value, you can also pick a point on-screen. Turn on *Polar Tracking* to ensure that the rotation angle is precise. In the example below the Incremental Angle value of *Polar Tracking* has been set to 30 degrees. This could be a more efficient workflow because you do not need to be concerned with whether or not an angle is positive or negative. Instead, you simply click when the object is located on the appropriate tracking angle.

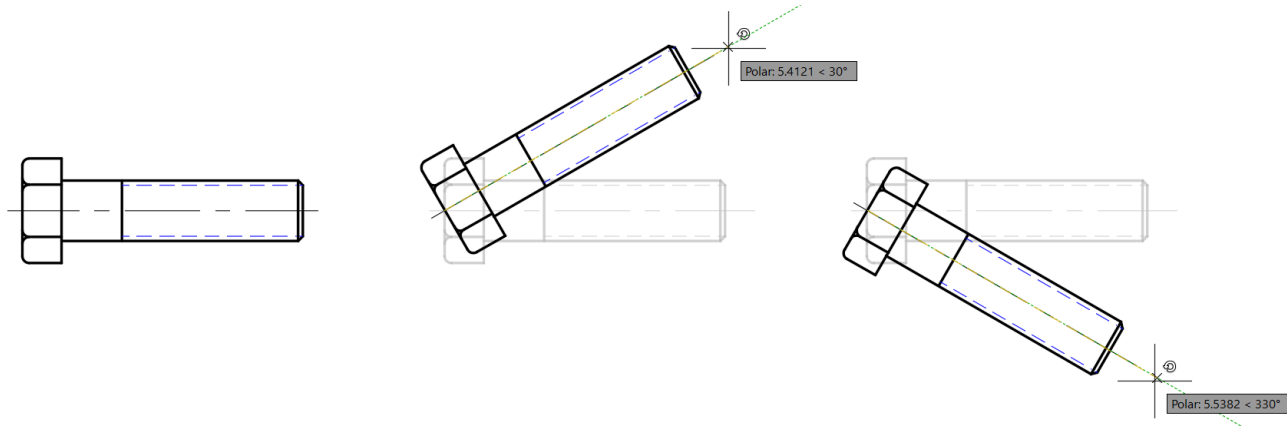

Specifying the Reference Angle

Occasionally when working in a drawing, you may find the need to rotate an object to return it to a standard orientation. For example, the bolt in the image to the right is currently at an angle, and it needs to be rotated until it is back to horizontal.

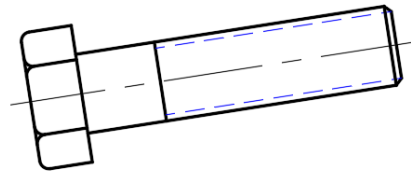

This is a fairly simple process if the object was rotated at a known angle, such as 30 degrees; you could simply rotate the object negative 30 degrees to return it to horizontal. However, if the object has been rotated at an unknown angle, the process could be more difficult. One possibility is to measure the angle from horizontal, then rotate using a negative value.

In the image to the right, the angle of the bolt has been measured and found to be nine degrees.

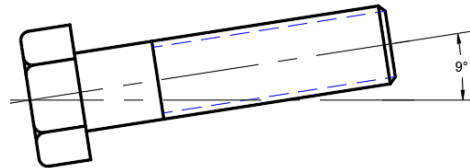

The first instinct might be to rotate the object negative nine degrees to return it to horizontal. This might not work precisely, because the nine degree dimension could be rounded off. A closer look reveals that the angle is slightly less.

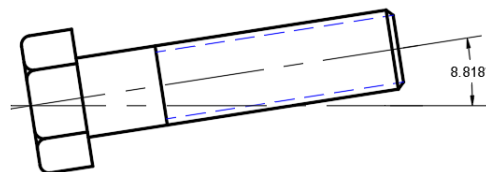

Using this new, more precise value could still lead to an incorrect drawing because this value is most likely rounded off as well.

The much more precise and quicker solution is to use the Reference option of the Rotate command.

In this example the centerline of the bolt will serve as the reference angle. Therefore, the left endpoint of the centerline will serve as the basepoint.

1. Begin the Rotate command and select the objects to be rotated.
2. Specify the basepoint.
3. Choose the **[Reference]** option in the Command line.

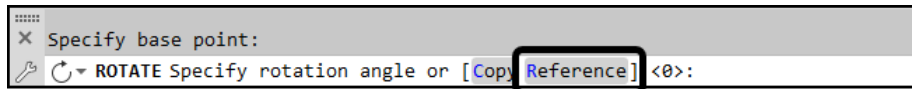
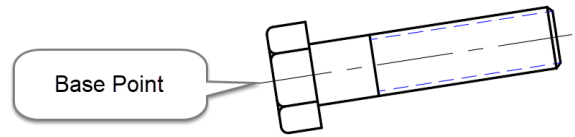

4. Select the two endpoints of the centerline to represent the new reference angle.

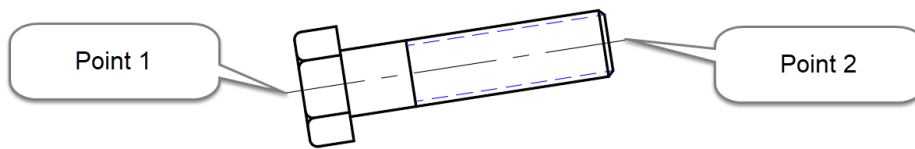

5. Move the crosshairs horizontally to the right of the basepoint along the **0** degree *Polar Tracking* angle.
6. Select a point to rotate the bolt into place.

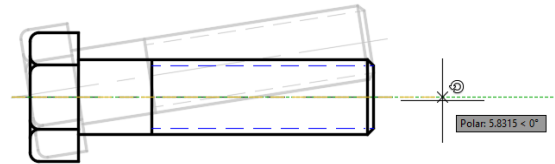

Exercises: Rotating Drawing Objects

In these exercises, you will rotate several drawing objects.

You do the following:

- Start the Rotate command.
- Select objects.
- Specify base points.
- Specify a rotation angle by typing a value.
- Specify a rotation angle with *Polar Tracking*.
- Use the reference option to orient drawing objects.

6.4.1 Rotating Drawing Objects

In this exercise you will use the Rotate command to adjust the orientation of several doors.

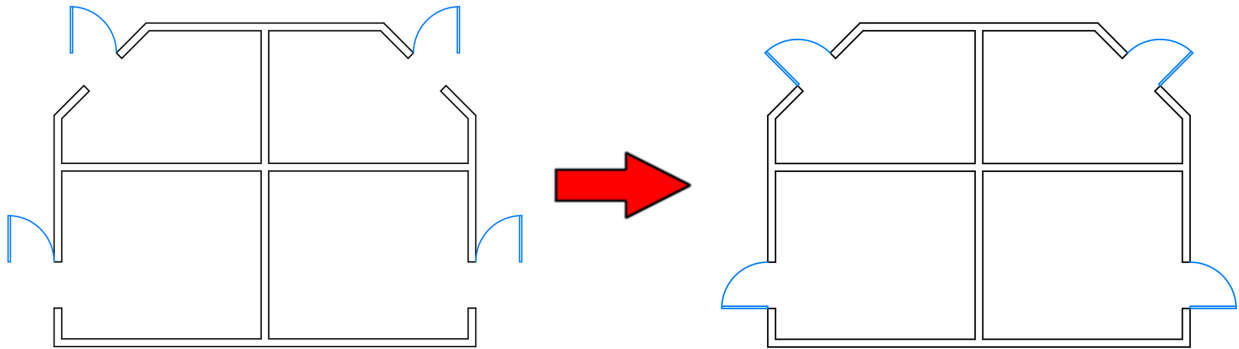

1. **Open** drawing **6.4.1 Rotating Objects 1.dwg**.
2. Set **Endpoint** as a *Running Object Snap*.

Four doors have been placed, but they need to be rotated into place. Start with the door in the lower left, then work clockwise around the building.

3. Zoom to the lower-left quadrant of the building.
4. Select **Ribbon: Home** ⇒ **Modify** ⇒ **Rotate**.

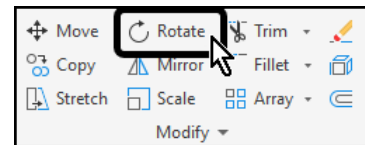

5. Select the door.
6. Press **[Enter]** at the keyboard to finish selecting objects.

You are now prompted to select the base point.

7. Select the point where the arc touches the wall to specify it as the base point.

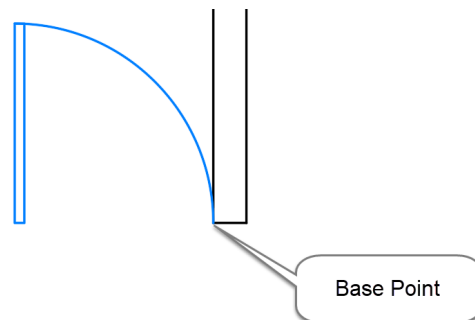

You are now prompted to specify the rotation angle.

8. At the Command line type **90** then press **[Enter]** at the keyboard.

The door is rotated into place.

9. Zoom to the upper-left quadrant of the building.

10. Select **Ribbon: Home** ⇒ **Modify** ⇒ **Rotate**.

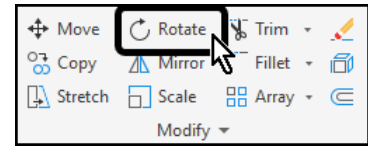

11. Select the door.
12. Press **[Enter]** at the keyboard to finish selecting objects.

You are now prompted to select the base point.

13. Select the point where the arc touches the wall to specify it as the base point.

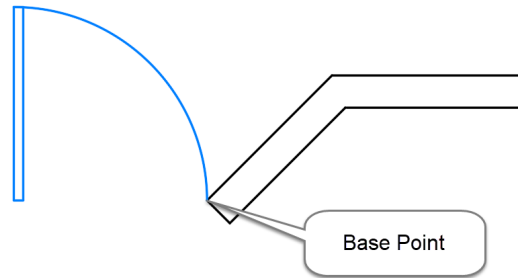

You are now prompted to specify the rotation angle.

14. At the Command line type **45** then press **[Enter]** at the keyboard.

The last two doors will be rotated in the clockwise direction, which will require negative rotation angles.

15. Zoom to the upper-right quadrant of the building.
16. Select **Ribbon: Home** ⇒ **Modify** ⇒ **Rotate**.

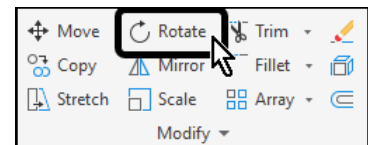

17. Select the door.
18. Press **[Enter]** at the keyboard to finish selecting objects.

You are now prompted to select the base point.

19. Select the point where the arc touches the wall to specify it as the base point.

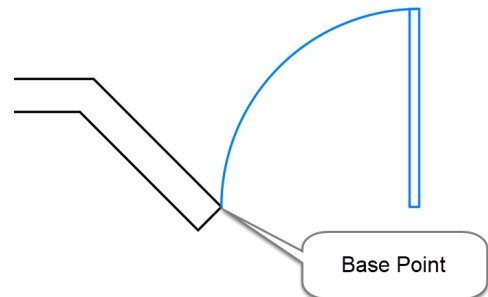

You are now prompted to specify the rotation angle.

20. At the Command line type **-45** then press **[Enter]** at the keyboard.

Next you will rotate the final door.

21. Zoom to the lower-right quadrant of the building.

22. Select **Ribbon: Home** ⇒ **Modify** ⇒ **Rotate**.

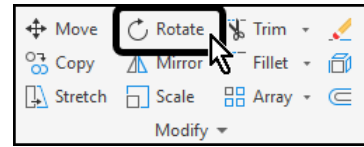

23. Select the door.

24. Press **[Enter]** at the keyboard to finish selecting objects.

You are now prompted to select the base point.

25. Select the point where the arc touches the wall to specify it as the base point.

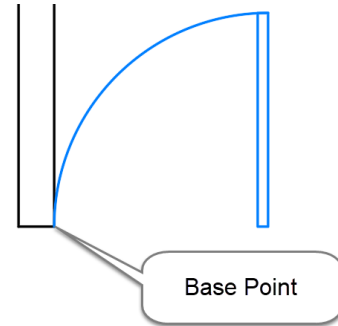

You are now prompted to specify the rotation angle.

At the Command line type **-90** then press **[Enter]** at the keyboard.

The completed drawing appears as shown.

26. **Save** the drawing.

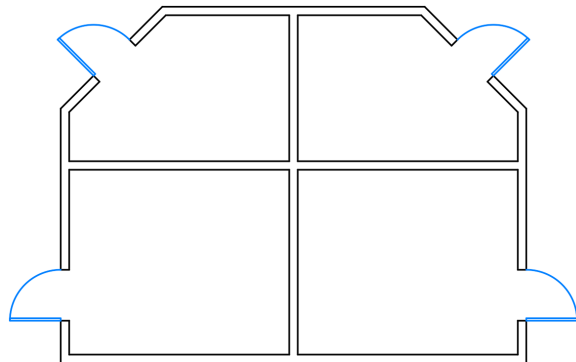

6.4.2 Rotating Objects with Polar Tracking

In this exercise you will use the Rotate command and *Polar Tracking* to speed up the rotate process.

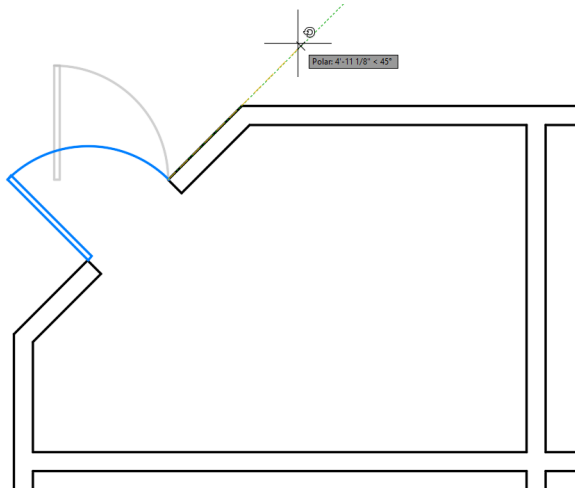

1. **Open** drawing **6.4.2 Rotating Objects 2.dwg**.
2. Set **Endpoint** as a *Running Object Snap*.
3. Select the fly-out arrow next to the *Polar Tracking* button and select **45** degree increment angles.
4. If necessary, select the *Polar Tracking* button to turn it on.

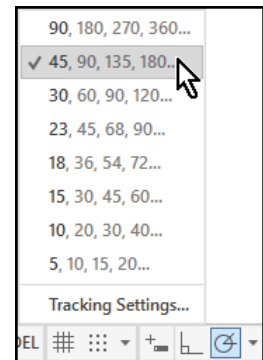

5. Zoom to the lower-left quadrant of the building.
6. Select **Ribbon: Home** ⇒ **Modify** ⇒ **Rotate**.

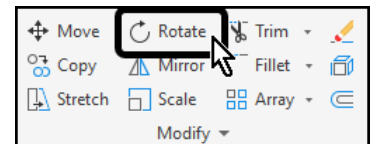

7. Select the door.
8. Press **[Enter]** at the keyboard to finish selecting objects.

You are now prompted to select the base point.

9. Select the point where the arc touches the wall to specify it as the base point.

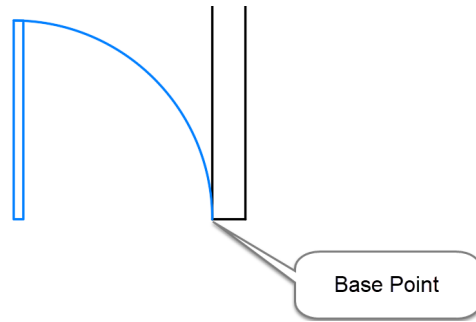

You are now prompted to specify the rotation angle.

10. Move the crosshairs above the previous point, until it snaps on to the **90** degree *Polar Tracking* angle, then select a point.

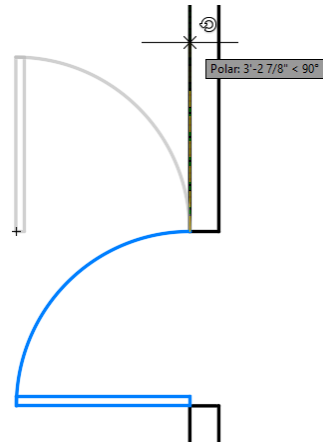

The door is rotated into place.

11. Zoom to the upper-left quadrant of the building.
12. Select **Ribbon: Home** ⇒ **Modify** ⇒ **Rotate**.

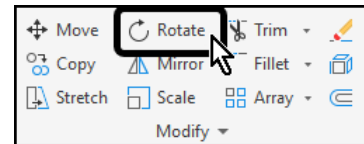

13. Select the door.
14. Press **[Enter]** at the keyboard to finish selecting objects.

You are now prompted to select the base point.

15. Select the point where the arc touches the wall to specify it as the base point.

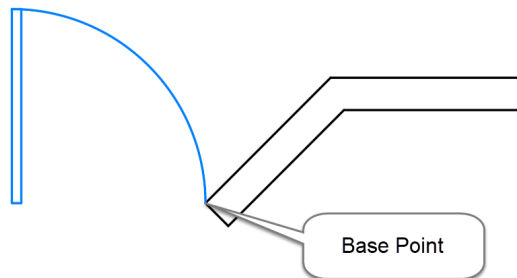

You are now prompted to specify the rotation angle.

16. Move the crosshairs above and to the right of the previous point, until it snaps on to the **45** degree *Polar Tracking* angle, then select a point.

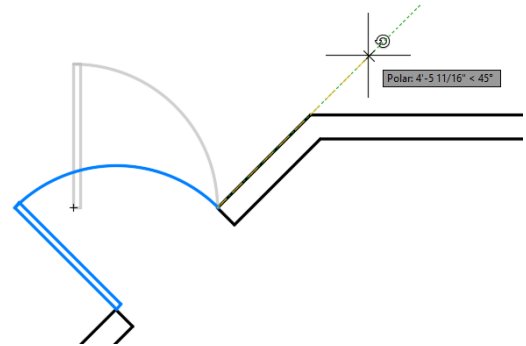

17. Repeat the process to complete the right side of the drawing.
18. **Save** the drawing.

6.4.3 Rotating Objects with the Reference Option

In this exercise you will use the Reference option of the Rotate command to adjust the orientation of an object.

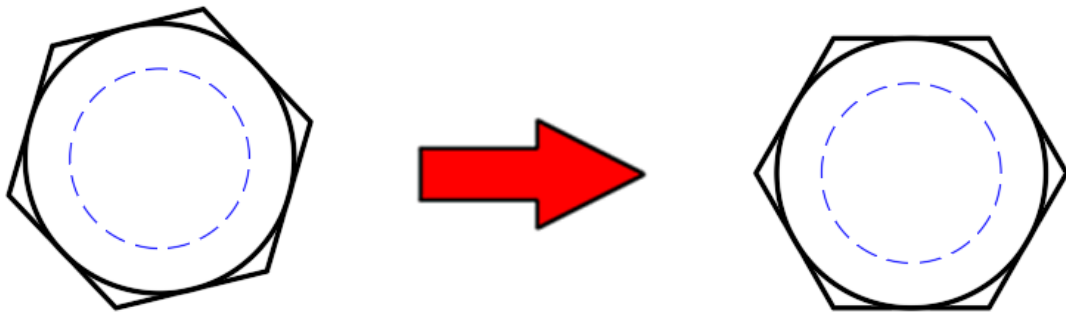

1. **Open** drawing **6.4.3 Rotating Objects 3.dwg**.
2. Set **Endpoint** as a Running Object Snap.

A bolt head has been rotated at an unknown angle. You will rotate it until the top and bottom edges are horizontal.

3. Select **Ribbon: Home** ⇒ **Modify** ⇒ **Rotate**.

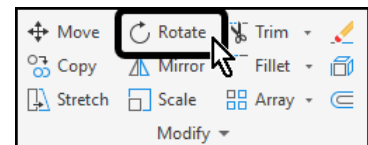

4. Select the objects that make up the bolt head.
5. Press **[Enter]** at the keyboard to finish selecting objects.

You are now prompted to select the base point.

6. Select the lower-left corner to specify it as the base point.

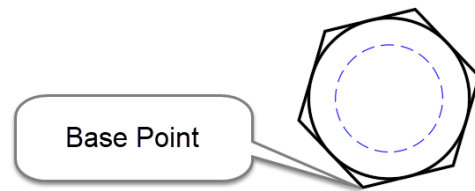

You are prompted for a rotation angle. By default, AutoCAD uses 0 as the reference angle, meaning that you are rotating from horizontal. In this case the reference angle should match the bottom edge of the bolt head. Since that value is unknown, you will select the two endpoints of that line to specify it as the new reference angle.

7. At the Command line select the **[Reference]** option.

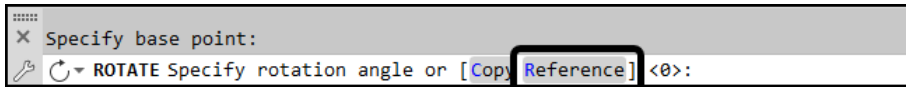

You are prompted to specify the reference angle.

8. Click the lower-left point.
9. Click the lower-right point.

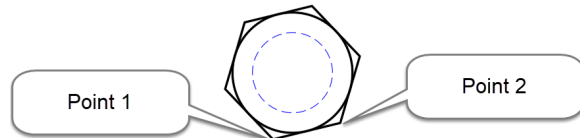

The reference angle now matches the bottom edge of the bolt head.

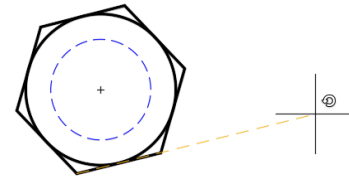

10. Move the crosshairs horizontally to the right along the **0** degree *Polar Tracking* angle.
11. Select a point to rotate the bolt head into place.

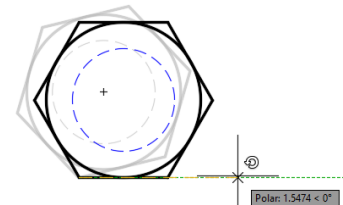

The top and bottom edges of the bolt head are now horizontal.

12. **Save** the drawing.

6.4.4 Challenge Exercise - Rotating Drawing Objects

In this exercise you will use the Rotate and Move commands to complete the kitchen layout.

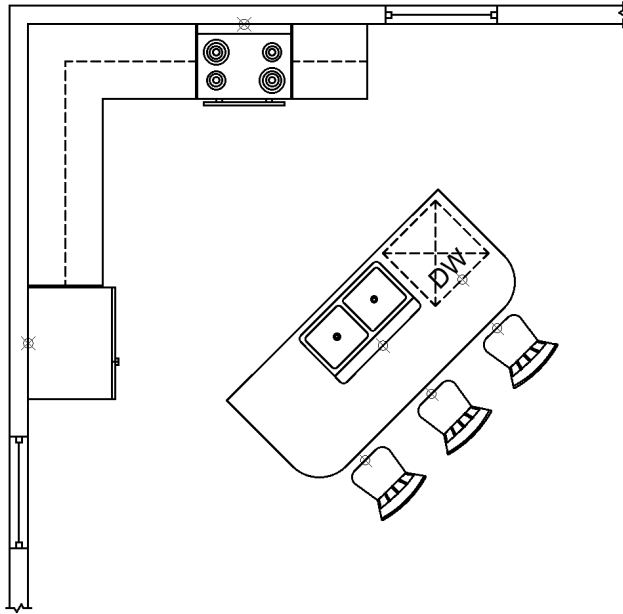

1. **Open drawing 6.4.4 Rotating Objects 4.dwg.**

The drawing contains a partial floorplan of a kitchen layout.

Also included are several objects that need to be placed in the floorplan including appliances, furniture, and windows.

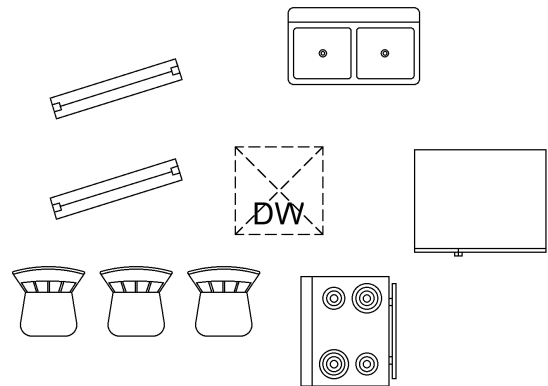

2. Rotate each object the appropriate angle, then move the object to the correct location as shown in the image above.

Points have been provided to aid in locating the objects properly. Enable the Node object snap to move the objects to the points.

The windows have been rotated to non-standard angles. Use the Reference option of the rotate command to rotate the windows to the proper angles.

3. **Save** the drawing.

Lesson Review

In this lesson, you learned how to rotate drawing objects both by typing angle values at the Command line and with the aid of *Polar Tracking*.

Index

[F2]	22	External Reference Fading	441
Absolute Coordinates	38	External Reference Path Type	441
Additional Tracking Angles	52	External Reference Type	440
Aligned Dimension	499	External Reference Updating	441
Angles	40	External References	438
Angular Dimension	499	External References Palette	439
Application Menu	5	File Tabs	6
Arc	139	File Types	11
Area	342	Fillet command	228
Associative Dimensions	503	Freezing and Thawing Layers	67
automatic save	15	Geometric Center Snap	108
automatic save files	15	Grip Editing	322
backup copy	15	Hatch patterns	375
Baseline Dimension	502	Help	6
Block Editor	424	Increment Tracking Angles	50
Blocks	393, 439	Inscribed	97
Boundary edges	215	Insert command	439, 449
Boundary Edges in Quick Mode	216	Insert Snap	110
Cartesian Coordinates	38	Inserting Blocks	393
Center Snap	108	Intersection Snap	108
Chamfer command	240	Joining Lines and Arcs	155
Changing the Layer of Existing Objects	66	Keyboard Options	21
Circle	83	Lasso	28
Circumscribed	98	Layer Properties Manager	69
Closing a File	16	Layer States	67
Closing a Polyline	154	Layers	66
Command Line	7	Layout Tabs	7
Command Line Options	22	Layouts	472
Continue Dimension	501	Leaders	518
Copy command	257	Line	33
Create Block command	421	Linear Dimension	498
Crosshairs	6	Linetype	70
Crossing selection method	27	Lineweight	71
Current Layer	66	List command	363
Cutting edges	205, 208, 218	Locking Layers	68
Cutting Edges in Quick Mode	206	Match Properties	362, 378
DesignCenter	401	Measure Angle	339, 340
Diameter Dimension	500	Measure Area	342
Dimensioning	496	Measure Commands	333
Direct Distance Entry	50	Measure Distance	335
Drafting Settings Dialog Box	106	Measure Radius	337
Drawing Units	334	Midpoint Snap	107
Drawing Window	6	Mirror command	264
Dynamic Blocks	399	Model Space	461, 473
Edit Polyline	153	Move command	169
Endpoint Snap	107	Multileader	518
Erasing Objects	25	Multiline Text	485
Explode	156, 287, 396	Multiple Drawings	16
Extend command	215	Navigation Bar	24
Extend Quick Mode	215	Nearest Snap	110
Extend Standard Mode	218	New	11
Extension Snap	129	Node Snap	110

Object Snap Tracking	127	Redo	25
Object Snaps	105, 129	Reference Angle	194
Offset command	311	Reference Option	178
Open	13	Relative Coordinates	39
ORTHO	50	Removing objects from a selection set	28
OSNAP	105	Ribbons	5
OTRACK	127	Right-Click Context Menus	23
Page Setup Manager	470	Rotate command	193
Pan	24	Running Object Snaps	105
Paper Space	470	Save	14
Parallel Snap	130	Save As	14
Path Array	300	Scale command	178
PDF data to import	450	Selection Techniques	26
PDF Import	449	Status Bar	7
Perpendicular Snap	109	Stretch command	187
Plot style table	462	Tangent Snap	109
Plotting	461, 470	Text	485
Polar Array	285	Text Window	22
Polar Coordinates	40	Tool Palettes	400
Polar Tracking	50	Tracking Angles	129
Polygon	97	Trim command	205
polyline	92	Trim Quick Mode	205
Polyline Width	152, 154	Trim Standard Mode	208
Polylines	151	Turning Layers On and Off	67
Properties palette	365	UCS Icon	7
Properties Panel	362	Undo	25, 34
QNew	11	Units	53, 334
Quadrant Snap	109	View Cube	6, 24
Quick Access Toolbar	6	Viewport Scale	474
Quick Measure	346	Viewports	472
Quick Select	367	Window selection method	27
Radius Dimension	500	Write Block command	423
Rectangle	92	Zoom	24
Rectangular Array	273		